

Odlučovače ropných látok zo železobetónu, pre zabudovanie do zeme

OLEOPATOR - K

koalescenčné odlučovače ropných látok

| Prietok [l/s] | Objem kalovej nádoby [l] | Priemer poklopu | DN pripojenie | B [mm] | C [mm] | T min [mm] | T max [mm] | D priemer [mm] | Najťažší diel [kg] | Celková hmotnosť [kg] | Obj. č. |
|---------------------------|--------------------------|-----------------|---------------|--------|--------|------------|------------|----------------|--------------------|-----------------------|----------------|
| ACO Oleopator NS 3 | | | | | | | | | | | |
| 3 | 300 | 600 | DN 100 | 395 | -870 | 725 | 5395 | 1240 | 1630 | 2300 | 740 501 |
| 3 | 650 | 600 | DN 100 | 385 | -1360 | 715 | 5385 | 1270 | 2250 | 2950 | 740 529 |
| 3 | 900 | 600 | DN 100 | 500 | -1290 | 1110 | 5500 | 1470 | 2960 | 4480 | 743 505 |

| | | | | | | | | | | | |
|---------------------------|------|-----|--------|-----|-------|------|------|------|------|------|----------------|
| ACO Oleopator NS 6 | | | | | | | | | | | |
| 6 | 600 | 600 | DN 150 | 410 | -1335 | 740 | 5410 | 1240 | 2300 | 2950 | 740 587 |
| 6 | 1200 | 600 | DN 150 | 440 | -1510 | 3180 | 4680 | 1470 | 3180 | 4680 | 743 507 |

| | | | | | | | | | | | |
|--------------------------------|------|-----|--------|-----|-------|------|------|------|------|------|----------------|
| ACO Oleopator NS 6 - 10 | | | | | | | | | | | |
| 6 - 10 | - | 600 | DN 150 | 420 | -845 | 750 | 5420 | 1240 | 1630 | 2310 | 740 563 |
| 6 - 10 | 1000 | 600 | DN 150 | 440 | -1510 | 1050 | 5440 | 1470 | 3200 | 4300 | 747 951 |
| 6 - 10 | 2000 | 600 | DN 150 | 405 | -1675 | 1015 | 5406 | 1800 | 4700 | 6850 | 743 509 |
| 6 - 10 | 2500 | 600 | DN 150 | 370 | -2000 | 980 | 5370 | 1800 | 5280 | 7100 | 743 511 |
| 6 - 10 | 5000 | 600 | DN 150 | 385 | -1925 | 1185 | 5385 | 2440 | 7950 | 9850 | 746 917 |

| | | | | | | | | | | | |
|----------------------------|------|-----|--------|-----|-------|------|------|------|------|------|----------------|
| ACO Oleopator NS 15 | | | | | | | | | | | |
| 15 | - | 600 | DN 200 | 410 | -1140 | 745 | 3410 | 1740 | 4100 | 5400 | 747 957 |
| 15 | 1500 | 600 | DN 200 | 430 | -1650 | 1040 | 5430 | 1800 | 4810 | 6600 | 743 523 |
| 15 | 3000 | 600 | DN 200 | 370 | -1410 | 1170 | 5370 | 2440 | 5750 | 8900 | 747 939 |

| | | | | | | | | | | | |
|--------------------------------|------|-----|--------|-----|-------|------|------|------|------|-------|----------------|
| ACO Oleopator NS 15 -20 | | | | | | | | | | | |
| 15 - 20 | 5000 | 600 | DN 200 | 390 | -2050 | 1190 | 5390 | 2440 | 7250 | 10250 | 746 929 |

| | | | | | | | | | | | |
|----------------------------|------|-----|--------|-----|-------|------|------|------|------|-------|----------------|
| ACO Oleopator NS 20 | | | | | | | | | | | |
| 20 | - | 600 | DN 200 | 410 | -1140 | 745 | 3410 | 1740 | 4100 | 5400 | 747 955 |
| 20 | 2000 | 600 | DN 200 | 395 | -1975 | 1005 | 5395 | 1800 | 5440 | 7100 | 743 525 |
| 20 | 4000 | 600 | DN 200 | 345 | -1695 | 1145 | 5345 | 2440 | 6350 | 9350 | 746 927 |
| 20 | 6000 | 600 | DN 200 | 450 | -2250 | 1250 | 5450 | 2440 | 7750 | 10750 | 746 931 |

NS 3 - NS 50

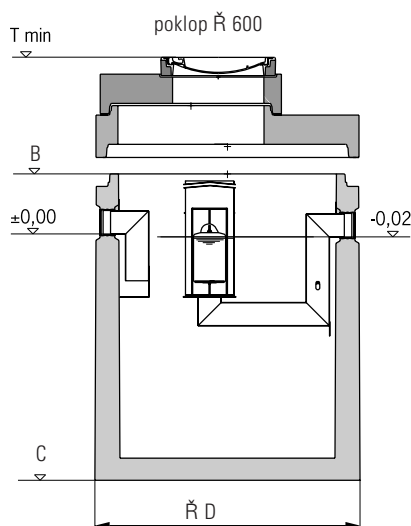

Legenda

T min = minimálna hĺbka zabudovania
T max = maximálna hĺbka zabudovania
B = vzdialenosť medzi dnom prítokového potrubia a hornou hranou nádrže
C = vzdialenosť medzi dnom prítokového potrubia a dnom nádrže
D = priemer nádrže
Pozn.: Pri výškovom nastavení poklopu treba uvažovať s 10 mm výškou na každú špáru medzi jednotlivými dielcami.

Pozn.: Trieda zataženia poklopu STN EN 124.
* NS - menovitá veľkosť (nominal size).



OLEOPATOR

NS 6-10

nastavitelné provedení

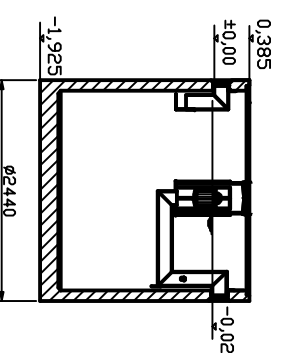
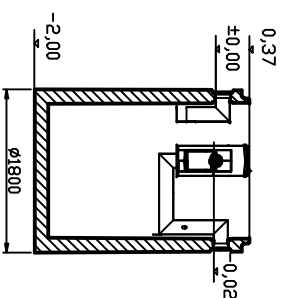
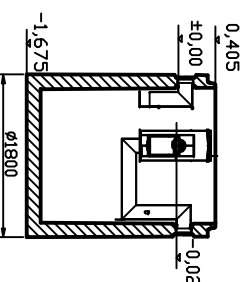
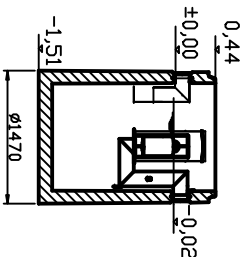
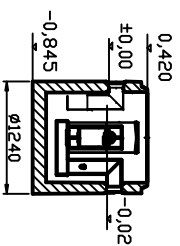
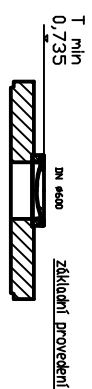
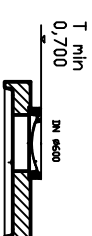
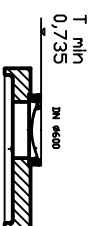
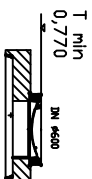
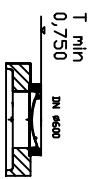
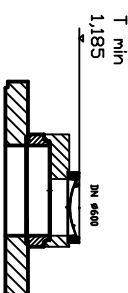
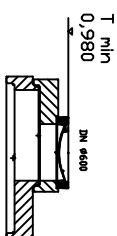
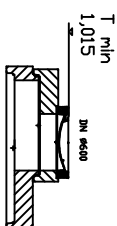
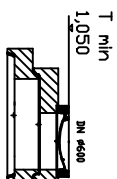

NS6-10

NS6-10/1000

NS6-10 SF2000

NS6-10 SF2500

NS6-10 SF3000

